

EIGER 3

LED PLASTER-IN IP44 FIXED DOWNLIGHT
DLD/EIGER3/PL/FI

DLD
CONTRACT

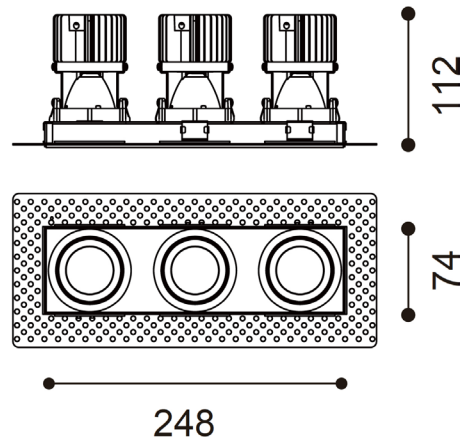
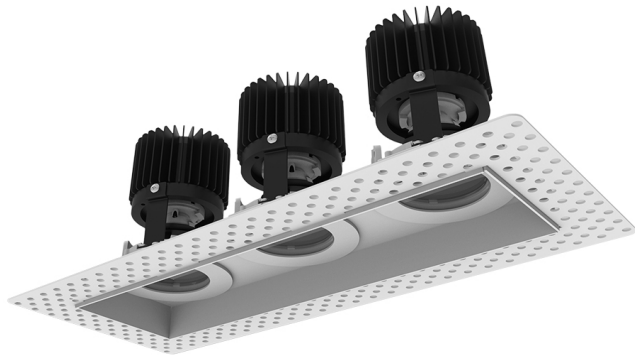

Dimensions

248 x 74mm, H.112mm

Cutout

260 x 78mm



- Removable light engine - simple twist mechanism
- IP44
- Complete with phase dimming driver
- Die-cast aluminium luminaire
- Forged aluminium heat sink
- Plastic PC reflector
- Bezel finish: white / black

EIGER 3

LED PLASTER-IN IP44 FIXED DOWNLIGHT
DLD/EIGER3/PL/FI

DLD
CONTRACT

TECHNICAL OVERVIEW

Power	Current	Voltage	LED	IP Rating	Nominal Flux	CCT	Beam Angle	CRI	Dimming
3x 12.9W	350mA	36.7V	CITIZEN	IP44	3x 1456lm	2700°K	3x 20°/40°	90+	Yes
3x 12.9W	350mA	36.7V	CITIZEN	IP44	3x 1524lm	3000°K	3x 20°/40°	90+	Yes
3x 12.9W	350mA	36.7V	CITIZEN	IP44	3x 1576lm	4000°K	3x 20°/40°	90+	Yes

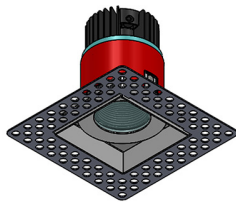
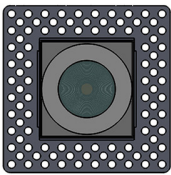
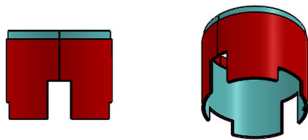
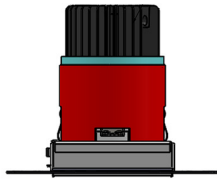

Fire rated canister diagram

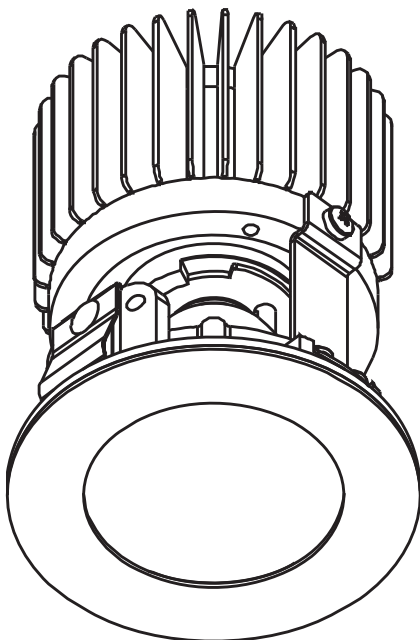

3 x Fixed **IP44**
H. 112mm

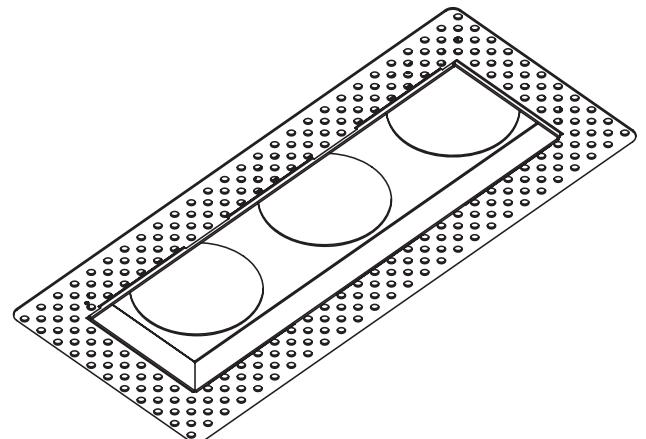

248 x 74mm
cutout: 260 x 78mm

EIGER 3

LED PLASTER-IN IP44 FIXED DOWNLIGHT
DLD/EIGER3/PL/FI

DLD
CONTRACT

PRODUCT CODE CONSTRUCTION

EIGER 3 LED IP44 PLASTER IN FIXED DOWNLIGHT

DLD/EIGER3/PL/FI / **[X]** / **[X]** / **[X]** / **[X]** / **[X]**

FIRE RATED:

[--] **[FRC3]**

None 3x Fire rated canister

LIGHT COLOUR TEMPERATURE (CCT):

[27K] **[30K]** **[40K]**

2700°K 3000°K 4000°K

BEAM ANGLE:

[20D] **[40D]**

20° 40°

WATTAGE:

[13W]

12.9W

FINISH:

[WH] **[BK]**

White Black



01189 889414



enquiries@dld-contract.co.uk



dld-contract.co.uk

DLD Contract Ltd
Unit 9 Brookside Business Centre
Church Road
Swallowfield
Reading
Berkshire
RG7 1TH